

Profile Series 8-Tank Monitoring & Display Panels. Firmware R3.1a

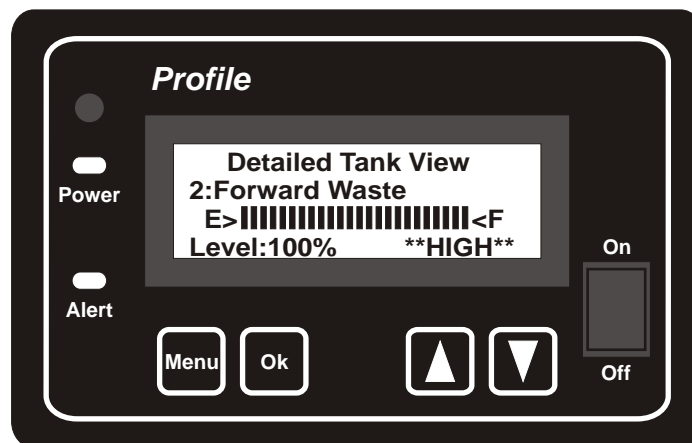
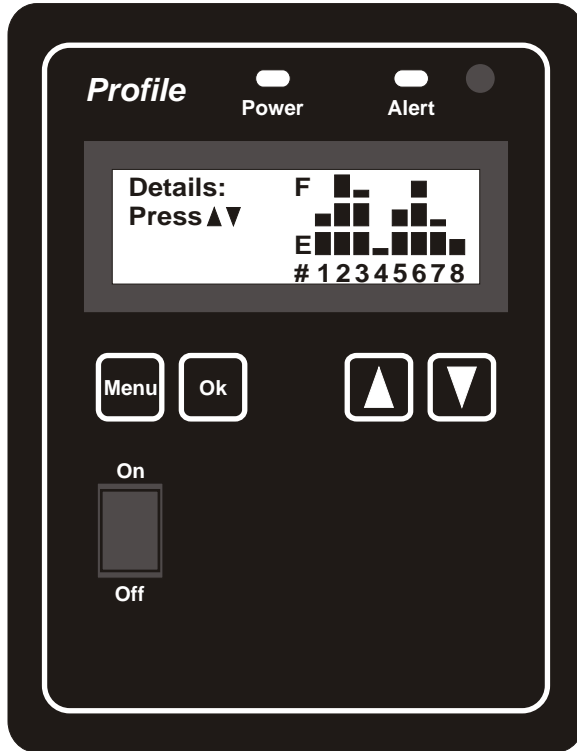

New Providence Marine Systems

Copyright © 2007

PROFILE SERIES

Table of Contents

| Topic | Page |
|----------------------------------|-------------|
| 1:Introduction | 2 |
| 2:Installation Guide | 3 |
| 3:Monitor Software Configuration | 9 |
| 4:System Calibration | 11 |
| 5:Troubleshooting | 12 |
| 6:Limited Warranty | 15 |
| 7:Product Registration Form | 16 |

Introduction

Have you ever been disappointed with the accuracy of a tank monitor? We have overcome the accuracy problem with tank and sensor profiling with EZ-Profile. What is EZ-Profile? EZ-Profile is our exclusive software algorithm developed specifically for our Profile series of monitoring panels. It significantly improves the accuracy of the displayed data by correcting for sensor type and oddly shaped tanks so common in the marine industry.

Our Profile series monitors are compatible with our own line of non-contact level sensors, non-contact sensors manufactured by several other companies, and even standard 240-33 Ohm float level sensors. If your LPG tank is outfitted with a 0-90 Ohm sending unit, we can display that too.

A gauge that is unwatched by the owner is little better than none at all. This monitoring system is not just a level gauge; it is a true tank monitor. Even if you forget to check your tanks regularly, the panel will autonomously scan them for you on a programmed schedule, then alert you when something is amiss with a red warning light and alarm chime (i.e. an empty fresh tank or a full waste tank).

All system settings are configurable by the owner by a series of easy to follow menus. The reading interval, names of monitored tanks, audible alarm settings, tank shapes--all are customizable by the owner at install time and can be changed at any time to tailor the system to your exact needs.

We have taken considerable time and effort to ensure that you have purchased the best marine tank monitoring system possible. Our Engineering and Sales staff has over five years experience in the Marine Industry and has launched several highly successful marine products. Capitalizing on this experience, we have addressed issues learned over the past five years and incorporated features missing from other systems. However, a quality product does not depend entirely on its design. In order to ensure continuing product quality we build all of our products on our state of the art electronics production line and test and inspect each and every monitoring system several times prior to packaging and shipping to the customer. This design represents our current best effort and is perhaps the best monitoring system available on the market today.

Key Features of The Profile 8 Tank Monitoring System

- 1) The owner or installer can set all panel and sensor channel parameters and tank calibrations via a series of easy to understand menus.
- 2) Display accuracy and linearity is significantly improved with our exclusive EZ-Profile software algorithm. When setting up each sensor channel the operator is asked to select a sensor type and basic tank shape. The EZ-Profile software then corrects the displayed bargraph for non-linearities associated with odd-shaped tanks (common in marine applications) and different sensor types.
- 3) This panel autonomously monitors from 1 to 8 separate fluid tanks and warns the owner when something is too high or too low via a red warning light which stays lit and an alarm chime which sounds periodically.
- 4) Tank levels are displayed on 4x20 backlit LCD text display.
- 5) Compatible with non-contact capacitive level sensors, 33-240 Ohm float-style sensors, and 0-5 volt output sensors which allows maximum flexibility when specifying sensors. This across-the-board sensor compatibility also makes retrofit onto an existing system very simple as it can take advantage of existing sensor and wire installations.
- 6) Will monitor and display data from a standard 0-90 Ohm LPG sending unit.
- 7) In the multi-tank view (default), all attached tanks are displayed at once as 12 position vertical bar graphs. In the detailed or single tank view, each tank level is displayed as a horizontal 24 position bar graph. In the detailed view the tank channel number, name, and alert status are also displayed. LPG level (if enabled by the user) is displayed as a percent on the multi-tank display screen..
- 8) Electrical connections made on the back of the panel on a pair of terminal blocks. Each connection on the terminal blocks are clearly labeled with a silk-screened legend to prevent mis-wiring.

Installation Guide

This monitoring system has been designed to be installed with common tools and materials by both marine professionals and boat owners. The installation process is fairly involved, but can be accomplished as a series of simple steps. We highly recommend you read this manual in its entirety and familiarize yourself with each step prior to beginning the installation. You should also read the owners manuals for each sensor type you are installing and become familiar with them as well. If you have any questions at all about the installation or setup process please contact our technical support staff. They will be happy to answer any questions you have to ensure a successful installation.

Included parts

The standard after-market panel kit contains either our original 8 tank display (the panel to the right below), or our Legacy monitoring panel (the panel to the left), four 510-Ohm resistors, a fuse holder with 1 amp fuse, and a replacement 1 amp fuse.

Figure 1: Standard after-market display panel kit.

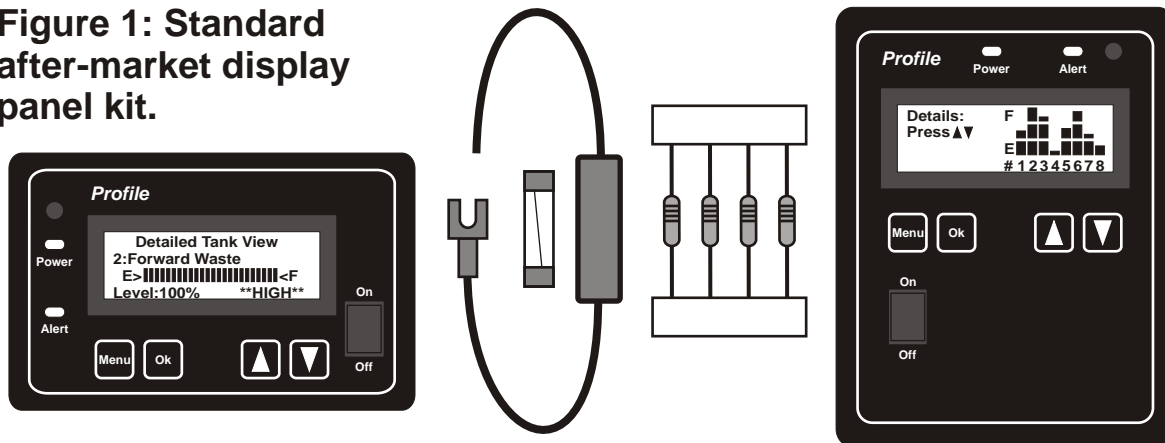

Required additional tools and materials

In addition to the contents of the monitor panel kit and various sensor kits, you will need to provide the following tools and materials to install the monitoring panel in your boat:

- 1) Tape measure
- 2) Pencil and permanent marker
- 3) Electrical and masking tape
- 4) Phillips screw driver
- 5) Keyhole or electric jig-saw appropriate to cut the panel installation hole
- 6) Wire cutter, stripper and terminal crimper for 18 AWG wire (inexpensive combination tools are usually available at most auto parts or hardware stores)
- 6) Electric drill and drill bits
- 7) 18 AWG stranded wire in 3 colors: red, blue, and black (make sure you have enough wire to pull all three wires from the panel location to each sensor)
- 8) Crimpable insulated butt connectors for 18 AWG wire (you will need at least 3 for each sensor channel you are intending to setup)
- 9) Crimpable insulated spade connectors for 18 AWG wire (you will need 2 to 3 for each sensor channel you are intending to setup)
- 10) 4 sheet metal screws and thin washers to secure the monitoring panel to your wall (select screws with head colors to match your boat decor)

You may also need additional tools and materials to install the various sensors for your system. Refer to the owners manuals for your sensors for a list of these items.

Installation: Panel Installation

The first step in installing the monitoring system is to select an appropriate location for the display panel itself. It should be in a location that is easy to see and access and be protected from weather or spilled fluids. You should also consider the ease with which you can pull the various power and sensor wires from the tank sensors to the proposed monitoring panel location. A good location should also have a minimum of 1½ inches of clearance for the depth of the display panel electronic circuit board, its attached terminal blocks, and sensor wiring.

Once you have selected the monitoring panel installation location, you will need to cut a rectangular hole in the wall in which to install the monitoring panel and its related wiring. If you are installing our original 8-Tank display this hole should be 5¾ inches tall by 4¼ inches wide; if you are installing a Legacy panel this hole should be 3 1/8 inches tall by 5¼ inches wide. Measure this opening carefully with the tape measure and mark the opening with a pencil. Take care to mark the opening so that it is square with the floor and walls of your boat for a good aesthetic appearance. When you are satisfied with the location and opening markings, use your saw to cut the opening as close to the lines you made as possible. Test fit the panel in the opening you just made and clean up or enlarge the hole if necessary so that the monitoring panel will slip in squarely and lay flat against the wall. Holding the panel in place in the opening, use a sharp object to mark the location on the wall of the panels four corner mounting holes. Remove the panel and use your electric drill and an appropriately sized drill bit to drill four pilot holes for the sheet metal screws that will be used to secure the panel. Do not mount the panel yet.

Installation: Sensor Installation

You should refer to the owners manuals for specific installation instructions for each sensor type we manufacture. 0-90 Ohm LPG sensors require a special insert be installed in your LPG tank and should only be done by a qualified person. 240-33 Ohm float sensors might already be installed in your tanks as they are quite common. If you are installing new float sensors, refer to documentation and instructions from the sensor manufacturer and take advantage of available adapters or mounting kits to keep their installation as simple as possible.

Installation: System Wiring

Once the panel opening is created and the sensors are all installed onto the sensor tanks, you can install the wiring which will attach each tank sensor to the display panel and the display panel to your boat's power system. You will use 18 AWG stranded wire for both of these tasks, preferably in three colors: red, blue, and black. Each sensor we manufacture uses a black wire for ground, a red wire for its power supply, and a blue wire for its output. A red and blue wire from each sensor must be pulled from each tank to the panel location. You may also pull a black ground wire from the sensor to the panel location and attach it to the panel's ground, or you can attach it to a good low impedance ground near the monitored tank.

If you are attaching 240-33 Ohm float sensors or a 0-90 Ohm LPG sensor, you only need to pull a single blue sensor wire from each to the display panel. No red power wire is required for either of these sensor types. You will also need to ground these sensors by pulling a wire back to the panel or attaching the ground wire to a good low impedance ground near to the sensor.

Route all wires so they are well away from potential heat sources (like the oven or exhaust pipes), and away from any moving parts which might damage the wire insulation. Also, do not use staples or nails to secure wiring as these might also cause damage to wire insulation potentially causing short circuits--use nylon ties to secure the wires instead .

Pull the wires from the each sensor location all the way through the hole you created for the panel leaving about a foot of slack on each wire so that it is easy to strip, crimp, and attach it easily to the back of the panel. As you pull each wire, take care to mark the ends of each wire with a bit of masking tape on which you write the name of each tank. This will prevent a lot of confusion later on when you terminate and attach each wire to the panel.

Installation: Wire Termination & Hookup

Note: You must attach sensors in order beginning with the CH1 SEN and PWR pair and count up with each sensor you hook up. For example if you have 4 sensors in your system you will attach a sensor to pair 1, pair 2, pair 3, and pair 4 leaving pairs 5-8 unattached. Do not skip sensor channel pairs.

Once all the wire is pulled through the boat, strip about ¼ inch from the ends of the wire on the tank sensor end and butt-connect to the installed sensor: red to red, blue to blue, and black to black. Also strip ¼ inch from the ends of the wire at the monitoring panel and terminate each red and blue wire with a spade connector. Connect the blue wire from each sensor channel to the terminal connection marked “CHn SEN” and corresponding red wire to the terminal marked “CHn PWR,” where n is a channel numbered 1-8. Repeat these sensor and panel connections for all installed sensors. Next attach all sensor ground wires to the boat’s ground either locally at each tank, or all together behind the monitoring panel. Figure 2 shows one of our standard sensors attached to sensor channel 1; Figure 3 shows one of our capacitive sensor rods attached to sensor channel 1. These figures depicts the attachment of our 2 most common sensors but applies to other sensor types we manufacture as well.

If your system includes 240-30 Ohm float-style sensors, you will need to install a 510 Ohm resistor (supplied with the monitoring panel) in between the PWR and SEN terminals for each sensor channel you are planning on attaching a float sensor to. Then use a spade connector to attach a wire between the SEN terminal and one wire of the float sensor. Connect the other wire on the float sensor to ground. Do not attach any other wires to the PWR terminal for that sensor channel. Figure 4 in this section shows a float sensor attached to the monitoring panel with its associated resistor attached to sensor channel 1. Using this figure as a guide, you can install a float sensor to any of the eight sensor channels.

If your LPG tank has a 0-90 Ohm level sensor attached to it, connect it to the panel as per the example in Figure 5 in this section. One wire of the sensor attaches to the terminal labeled “LP” on the terminal block with a spade connector. The other LPG sensor wire should be grounded. Note: an LPG sensor can not be attached to any of the other eight sensor channels; an LPG sensor can only be attached to the LP terminal.

Once all the sensors are connected to the display panel, it is time to attach the panel itself to a source of 12V power as shown in Figure 6 in this section. Make sure that the panel’s power switch is off before hooking the panel up to power. Attach the spade connector end of the included fuse module to the terminal labeled 12V and butt connect its other end to a source of 12V power with a length of red 18 AWG wire. Attach a spade connector to a length of black and attach it to the terminal labeled GND (right next to the power terminal). Connect the other end to a good low-impedance ground.

Final Installation

Secure the panel into the hole you made in the wall. Initially, use only two screws to hold it in place in case you need to make any changes in the wiring. Do not over tighten these screws as you will damage the Lexan face graphic causing it to wrinkle at the corners. We recommend the use of a very thin washer under the screw head to prevent damaging the face.

Once you finish testing and calibrating the system (described in the following sections) and everything works well, secure the panel in place permanently with all four corner screws.

A Note on The Included Figures

The figures on the following pages show terminal electrical connections as they appear on our original 8-Tank display panel. If you are installing one of our Legacy panels, you will note that the terminal block arrangement is slightly different than in the figures on the following pages. As you make your electrical connections on the panel just make sure that your wires are attached to the properly *labeled* terminal per the instructions above.

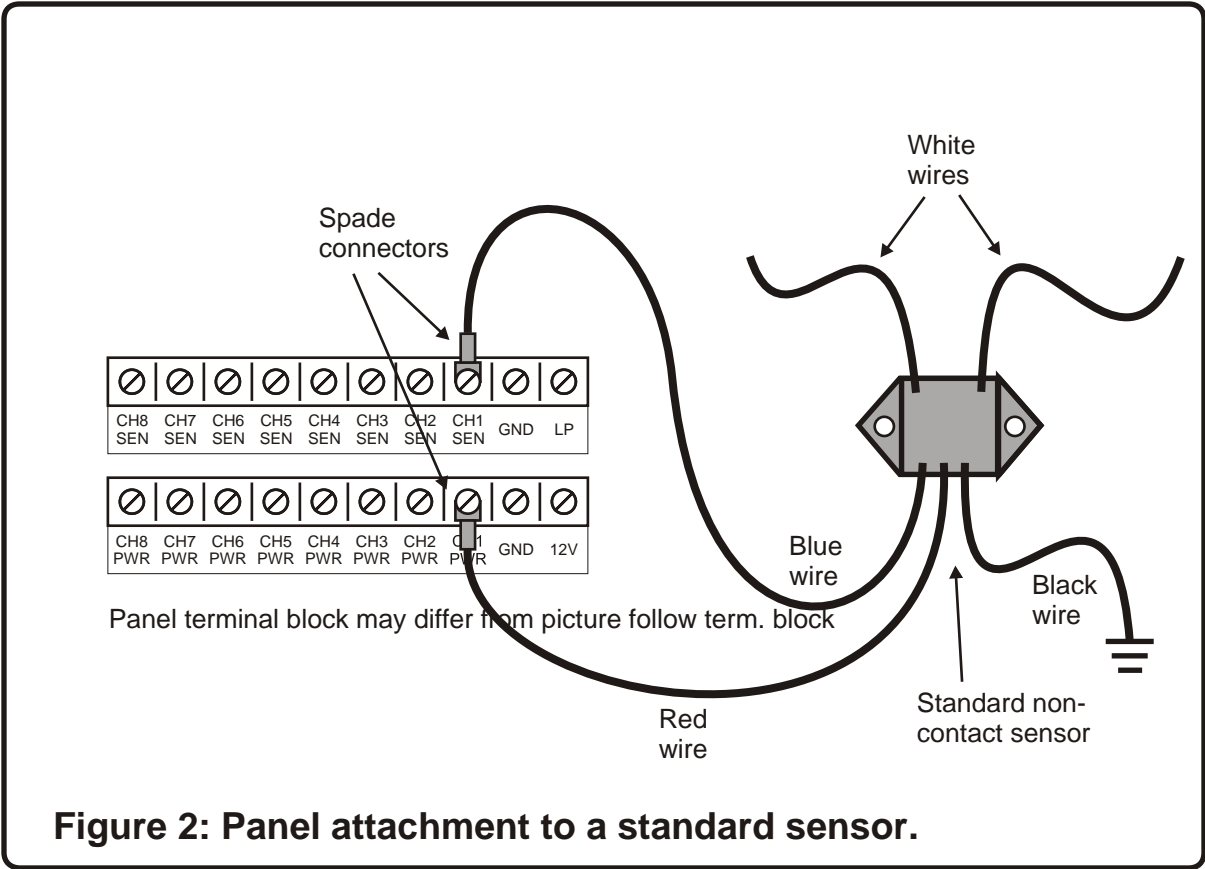

Figure 2: Panel attachment to a standard sensor.

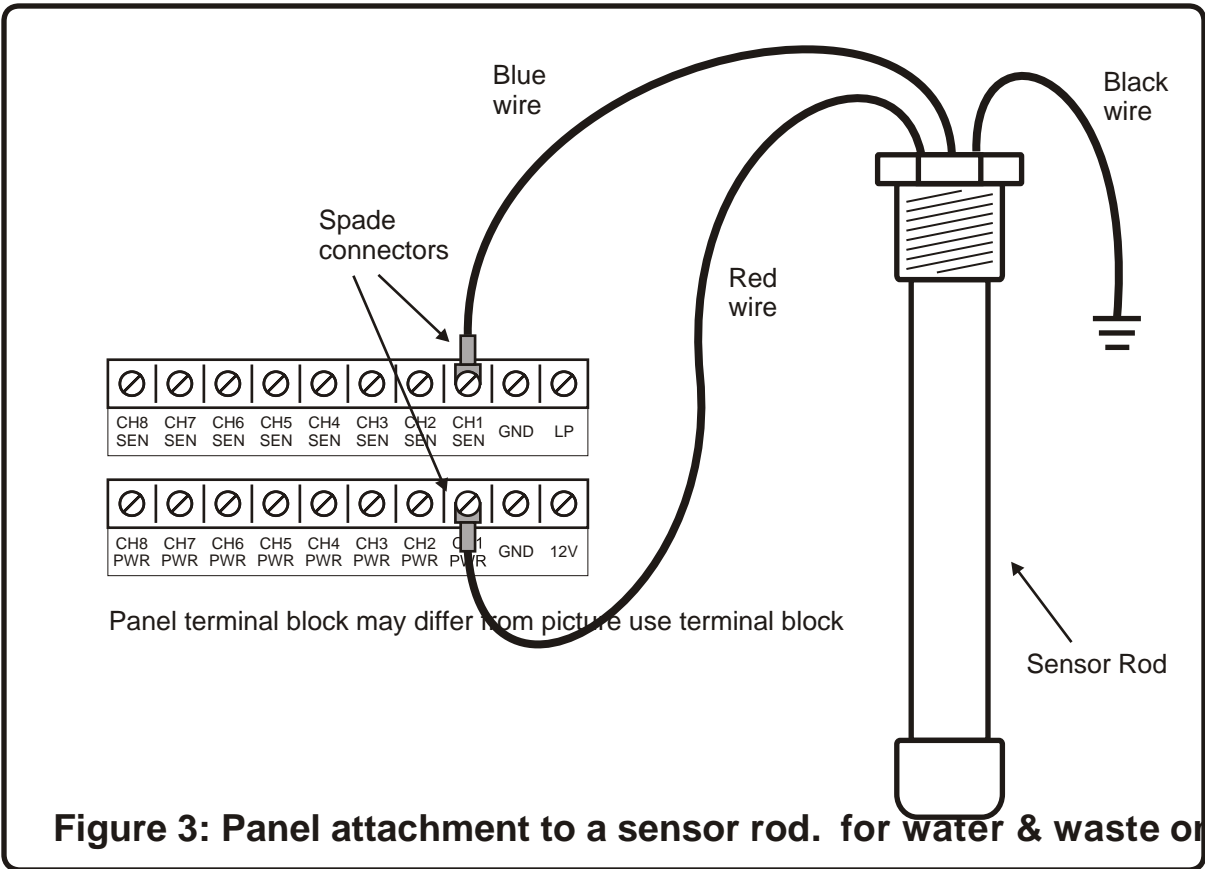

Figure 3: Panel attachment to a sensor rod. for water & waste only

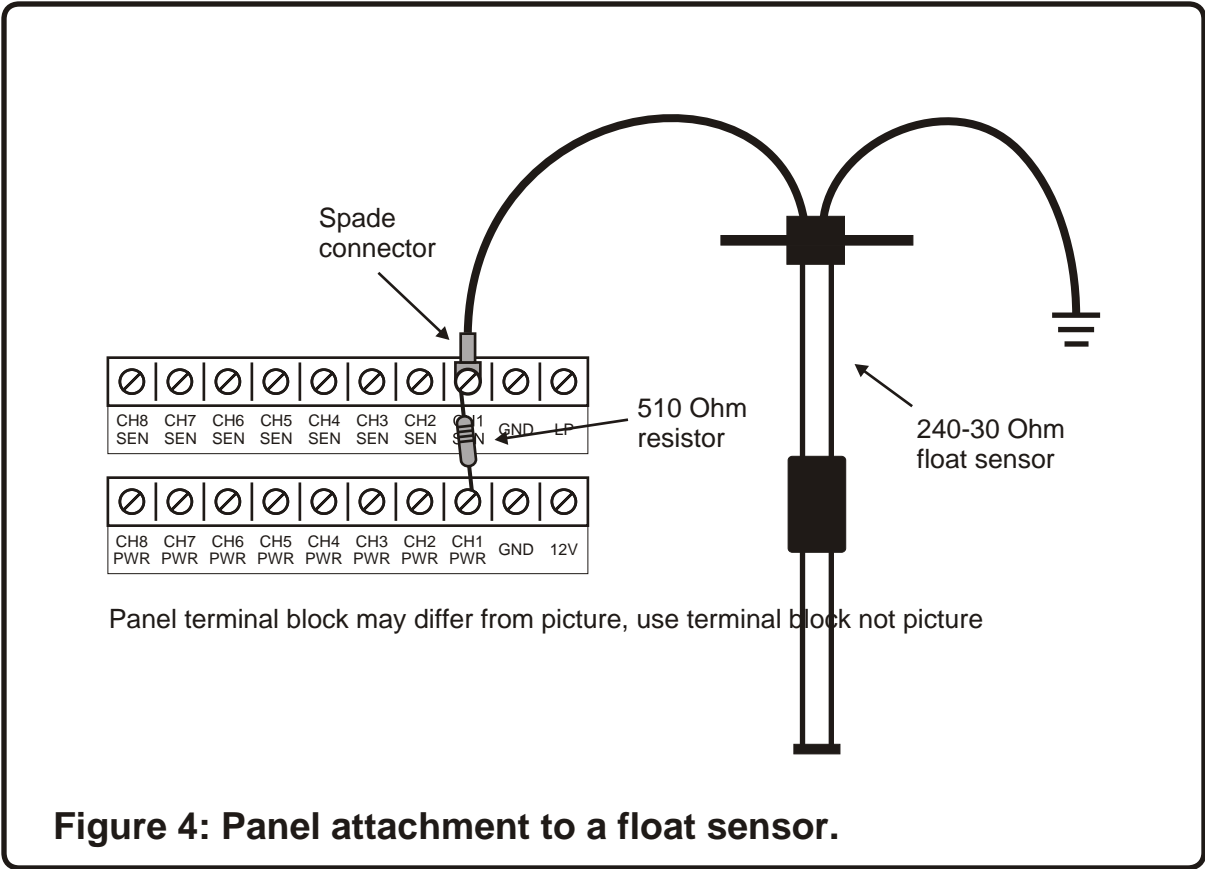

Figure 4: Panel attachment to a float sensor.

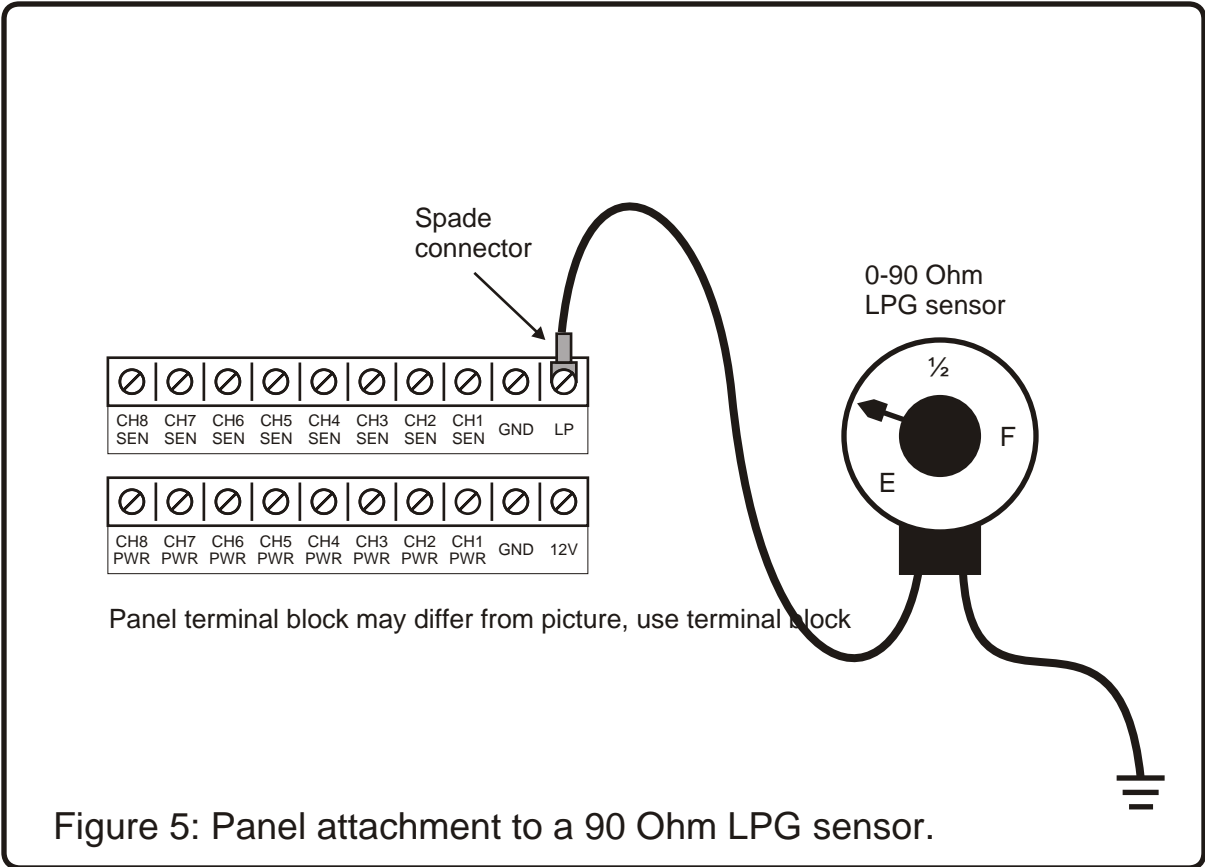
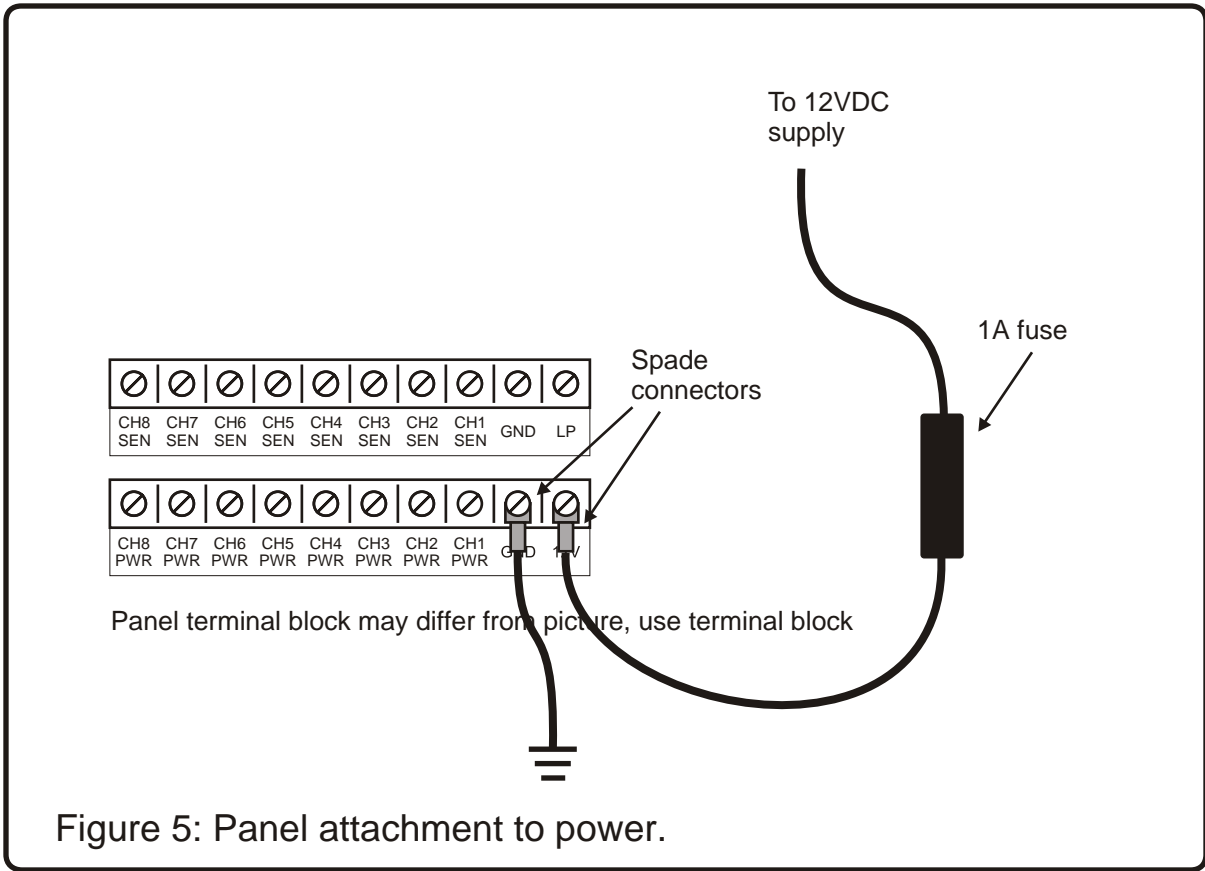

Figure 5: Panel attachment to a 90 Ohm LPG sensor.



2:INSTALLATION

Monitor Software Setup

After the panel installation is complete per the instructions in the previous section, it is time to set up the monitoring panel's software. This process is divided into two parts: (1) panel configuration and (2) sensor channel configuration. You should go through the panel configuration first to set up basic panel parameters then follow that with the setup of each sensor channel.

Note: if you think you have made a mistake or want to review a setting you just made as you navigate through the setup menus, you can press the MENU key to back up to the previous screen.

Step 1: Panel Configuration

The first step in configuring the monitor is to set up the basic panel settings. The steps for this process are as follows:

- 1) Set number of tanks to monitor
- 2) Monitor a 0-90 Ohm LPG sensor
- 3) Enable or disable all audible alarm chimes
- 4) Enable or disable audible alarm chimes at night
- 5) Set the time interval to read all tanks and sound audible alarms

To enter the setup menu press MENU then press OK to select setup. The next screen prompts you to either press the up arrow button for panel setup or the down arrow for sensor setup. Press the up arrow button as you want to set up panel settings first.

Press the OK button after you have read the welcome screen. The first menu screen prompts you to select the number of tanks to monitor. Use the up and down arrow buttons to either increase or decrease the number of tanks attached. When the correct number is displayed press the OK button to store it.

The next screen allows you to monitor a 0-90 Ohm LPG sensor. If you have attached an LPG sensor to the panel, press the up arrow key to monitor and display its data. The down arrow key disables the LPG function. Press OK to store this setting and move on.

Next you are asked if you want to enable or disable the alarm chime. When disabled, this parameter silences the alarm chime completely, day or night. The up arrow key enables the audible alarm chime and the down arrow key disables the audible alarm chime. You can also choose to separately enable or disable the audible alarms for each sensor channel when you set up each sensor channel later on. Press OK to store and continue.

The next setting also relates to the audible alarms. It lets you enable or disable the alarm chime at night. This panel is equipped with a light sensor that is used to activate the LCD display backlight when it is dark in the boat. When the night alarms are disabled, this same sensor will suppress the audible alarm chime after dark. Press the up arrow key to enable night alarm chime; press the down arrow key to disable the night alarm chime. Press OK to store and continue.

The next setup screen lets you select the time interval for the panel to autonomously read all attached tanks. Pressing the up arrow key increases the time interval by 5 minutes; the down arrow key decreases the time interval by 5 minutes. Keep in mind that the sensor reading time interval is also the interval at which the alarm chime will sound (if any attached tank is either too high or too low). The default value for this setting is for 120 minutes (2 hours). Press the OK button to store and go on to the final setup screen.

The final menu allows you to set the light sensor threshold used by the display panel to turn on the LCD backlight and mute the alarm chime. If the backlight does not come on at a light level you are comfortable with you can try increasing or decreasing this threshold value until the light sensor performs well given your ambient lighting conditions.

Once the panel settings are set to your satisfaction you need to configure each active sensor channel.

Step 2: Sensor Channel Configuration

A variety of settings are now required for each sensor channel. A list of these settings:

- 1) Select first and second descriptive names for each sensor channel
- 2) Setup each sensor channel to alert on full or empty
- 3) Enable or disable the audible alarm chime for each sensor channel
- 4) Select sensor type and read time
- 5) Select basic tank shape

From the main menu, select setup then press OK to enter the setup menu. Then press the down arrow button to enter the sensor channel setup menu and press OK again after you read the welcome screen. Follow the instructions below for each active sensor channel.

First select the sensor channel to setup. Press the up or down arrow keys to select the sensor channel by number, then press OK key to continue.

The next two screens in this menu allow you to select the descriptive name for each sensor channel. This is this name which is displayed with the sensor channel number on the detailed (single channel) display above the 24 position bargraph. The first screen will ask you to select a first name for the selected sensor channel. Press the up and down arrow keys to scroll through the different possible first names then press OK to store it. The next screen is used to select the second descriptive name. Again, use the up and down arrow keys to scroll through the possible names then press OK to store this name as well. Using these 2 screens you can select names like "Forward Fresh," "Aft Waste," "Port Diesel," "Waste Water," etc... for each sensor channel. You should select first and second names that sufficiently describe the tank that is attached to each sensor channel.

Following naming each channel, you will be asked if the panel should warn you on full (for a waste tank) or on empty (for a fresh or fuel tank) for each sensor channel. Press the up arrow button for full or the down arrow button for empty then press OK to store this value.

Next you will be asked to enable or disable the alarm chime for the selected sensor channel. Pressing the up arrow button enables the alarm chime, pressing the down arrow disables it. Press OK to store and go on. Note: this parameter will select whether or not you want to hear the audible alarm for the selected sensor channel only. If the audible alarm chimes were disabled during panel configuration, then no alarms will sound regardless of the setting of this parameter.

Now you will be asked what type of sensor is attached to the selected sensor channel. This information is used by our EZ-Profiler software algorithm to improve the accuracy of the displayed bargraph by correcting any sensor non-linearities. The different sensor types are: (1) "Foil," a solid-state sensor which is installed externally on the outside wall of a plastic tank, (2) "Rod," another solid-state sensor which is constructed inside a PVC rod and is installed inside a tank through a threaded access hole in the top, (3) "Linear V," a sensor whose output is a linear voltage in the range of 0V for empty to 5V for full, and finally (4) "Float," the traditional 33-240 Ohm float sensors manufactured by a variety of companies (i.e. Wema). Scroll through the four possible sensor types with the up and down arrow buttons then press OK to store it and go on.

Some sensor types require additional reading time for the sensor output to stabilize. Specifically, 240-33 Ohm sensors manufactured by Centroid have a "needle pegging" feature which holds the sensor output at a full level for about a half-second; this sensor type requires that the additional sensor polling time to be enabled. When disabled the sensor polling period is set 250mS (1/4 second), when enabled this period is set to 750mS (3/4 second). To enable the additional polling time press the up arrow, to disable it press the down arrow. If you are unsure if you need the additional time, leave this disabled. If the sensor always reads full, try enabling this feature.

Lastly, you will select the basic tank shape for the selected sensor channel. This data is also used by the EZ-Profiler algorithm to improve the displayed bargraph by correcting for the tank shape. The different shapes are: (1) "Square" for square or rectangular tanks, (2) "Tapered" which is slightly narrower at the bottom than at the top, (3) "Triangle" which is has an even more exaggerated taper, and (4) "Circular" which has a round cross-section. The default cross-section is square, but if you find its accuracy lacking, try the tapered setting. If you need to apply more correction, try the triangle setting. Use the up and down arrow keys to select the shape then press OK to store it.

You will now be asked if you need to set up another sensor channel. By pressing the up arrow key you will be taken back to the first screen in the sensor channel setup menu to select another sensor channel to configure. You should repeat this setup process for all sensor channels attached to the panel. When you have set up each sensor channel you can exit the sensor channel setup menu by pressing the down arrow button.

When you have finished setting up each sensor channel you will be reminded that you will need to calibrate each sensor channel for both empty and full.

Sensor Channel Empty/Full Calibration

Once the panel is installed and the panel software is configured, each sensor channel needs to be calibrated for empty and full tank conditions. The exception to this might be for tanks that have 33-240 Ohm float sensor attached. When you select this type of sensor during sensor channel setup, basic empty and full values are automatically stored that should be appropriate for your tank.

To enter the calibration screen press MENU from the main display screen to enter the main menu. Next press the down arrow button once and then OK to select calibration; this places you in the calibration sub-menu. Use the up and down arrow buttons to scroll through all of the attached tanks, then press OK to select the tank you want to calibrate.

The next screen prompts you to press the up arrow button for a full tank, or the down arrow button for an empty tank. You will need to set calibration points for both, once for full and once for empty. The next screen will ask if you are certain you want to program the calibration point, press the up arrow button to program the value and the down arrow button if you wish to abort.

Empty Calibration

What exactly is an empty tank? The answer to this question might not be as obvious as it sounds. In many cases an empty tank might not be completely empty as it is common in marine applications for some fluid to drain back into a waste tank after pump out. We recommend that you calibrate the empty point to a "pumped out empty" level in which you pump out a waste tank then wait until the outlet plumbing has had enough time to completely drain back into the tank. This way, when you set the empty calibration point of the tank, you are actually setting it to empty point of the true usable volume of the tank.

Each tank in your system will need its empty calibration points set. As each tank is pumped out (waste tanks) or are drained through normal usage (fresh tanks), enter the calibration routine as described above, select the tank to be calibrated and press the down arrow key for empty. Finally, confirm setting the point when prompted by pressing the up arrow key.

Full Calibration

Each tank in your system will also require a calibration point set when each tank is full. A good time to calibrate a waste tank is just before pumpout, and a good time for a fresh or fuel tank is just after fillup. To set the full calibration points, enter the calibration routine as described above, select the tank to be calibrated and press the up arrow key for full. Finally, confirm setting the point when prompted by pressing the up arrow key.

Error Checking

The calibration software has some error checking capabilities. If after you set a calibration point you see an error message, it may mean that a full point is being set which is equal to or less than the empty point, or an empty point which is equal to or greater than the full point. When an error occurs, the calibration routine sets default empty and full values. This return to default values clears possible bad calibration data which might make the sensor channel difficult to properly calibrate (i.e. an empty calibration value erroneously set with a full tank would otherwise prevent the setting of a proper full value until the empty point is set back to an appropriate empty value). If you continue to see a calibration error after re-attempting calibration and re-checking the tank levels, you may actually be experiencing a problem with the wiring between the sensor and panel (i.e. a disconnected power, sensor return, or ground wire to the sensor) or a bad sensor. If you suspect this may be the case, check the troubleshooting section in this manual.

System Troubleshooting

There are several factors that affect proper operation of this monitoring system. Proper calibration is critical to accurate tank level display. Therefore, the system should be calibrated with the boat as close to level and in conditions as calm as possible. A rocking boat or listing to one side will certainly affect the position of fluid within a tank and hence the quality of a calibration point. Also, depending on where the sensor strips are located on the outside wall of the tank, the reading may be somewhat sensitive to the pitch of the boat (due to fluid sloshing either up against or away from the sensor elements mounted to the tank wall). Keep this in mind when interpreting what otherwise might be a malfunctioning sensor or display.

Some tanks may be impossible to completely drain or may refill with a small amount of fluid after pumping out due to fluid left in the drain plumbing which may drain back into the tank. If you calibrated empty on such a tank when it was completely dry (as in a factory installation), it may read that there is some fluid in the tank even when pumped empty. If this is the case, simply recalibrate the empty point after pumping out and allowing to "settle" to an actual "empty" level.

Other problems, possible causes, and solutions are listed below. This list is by no means comprehensive, but it should cover most common problems or questions you might have. If your problem is not listed here or if the remedies suggested below do not solve your problems, our technical support staff would be happy to offer you whatever advice or assistance you need to get you up and running quickly.

Problem:

Panel does not turn on with power switch.

Possible Causes:

Blown fuse or disconnected power or ground wires

Test / Remedy:

Check fuse on power wire. If bad, replace. Check that power and ground wires are properly attached, repair if necessary. If either of these remedies do not fix the problem contact New Providence Marine Technical Support for additional instructions.

Problem:

A tank channel always reads full, empty or never changes regardless of fluid level

Possible Causes:

- 1) Improperly calibrated tank
- 2) Damaged wiring between the display and sensor module
- 3) Damaged or improperly installed sensor foil
- 4) Damaged sensor module

Test/Remedy:

- 1) Recalibrate tank for empty and full and recheck.
- 2) Check the wire connecting the sensor module to the display panel. Check that all wires are attached properly and that there is no damage along the wire run (staples through wires are a common problem to look for). Repair any problems found and recheck.
- 3) Check that the sensor foil is installed according to the instructions in the sensor owners manual. Also check that there is nothing "shorting out" the sensor foils (i.e.: metal object touching both foils), or that a large metal object is too close to the foils. Finally, check that the white wires attached to the sensor module have not disconnected from the copper patches or that the copper patches have not come loose from the aluminum sensor foil. Correct any problems found.
- 4) If you have checked the wiring and sensor foil and nothing appears incorrect and if you have recalibrated the tank and it is still not reading correctly, the sensor module on the tank itself may be damaged. You can look at the raw output from the module in the diagnostic mode. To enter this mode press the MENU button from the main display, scroll down to the "Diagnostic" listing with the arrow keys and press OK. The 3 digit number at the upper right of the screen shows the raw sensor output of the channel identified on the upper left of the

screen (scroll up or down with the arrow keys until the tank you are interested in is displayed). The output for an empty tank should be between 000 and 50; a full tank should read between 150 and 200. If the readings do not change with tank level changes, or are well outside of the values given here, contact New Providence Technical Support for additional instructions or to arrange for a replacement sensor module to be sent to you.

Problem:

A float sensor attached to the panel is displaying data in the wrong direction (i.e. a falling tank level looks like it is actually rising).

Possible Cause:

Incorrect sensor type was selected during sensor channel setup

Test / Remedy:

Re-setup the problem sensor channel by pressing the MENU button from the main display, then pressing OK for "Setup," and finally the down arrow button for sensor channel setup. Repeatedly press the OK button until the screen for sensor type selection is displayed then use the up and down arrow keys to change the sensor to "Float," then press the OK button to store the value. Return to the main display and re-check to see that the tank level is now displaying properly.

Problem:

Audible alarm chime is not sounding as expected

Possible Causes:

- 1) Global audible alarm has been disabled during panel setup
- 2) Night audible alarms have been disabled during panel setup
- 3) Audible alarms have been disabled for certain tanks during sensor channel setup
- 4) Improper empty/full warning conditions have been programmed during sensor channel setup

Test/Remedy:

1) & 2) Re-check the global audible alarm settings in the panel setup routine
3) & 4) Re-check the audible alarm settings and empty/full warning conditions for all attached sensor channels in the sensor channel setup routine. Remember that fresh tanks should alert on an empty condition and a waste tank should alert on full. If these remedies do not correct the problem you might have a bad audible alarm (in the case that no alarms chimes are heard), or a bad light sensor (in the case that the alarm is heard at night even when night alarms have been disabled). If you suspect either of these cases, contact New Providence Marine Technical Support for additional advice.

Problem:

No LCD backlight turns on.

Possible Causes:

- 1) Boat interior is too bright
- 2) Light sensor threshold value improperly set
- 2) Damaged light sensor or backlight circuitry

Test/Remedy:

A light sensor governs the operation of the LCD backlight and when enough light is present the panel software will de-activate it. If the LCD backlight does not come on even in total darkness, it may be that the light sensor threshold value is improperly set. You can increase or decrease this threshold value in the panel setup menu described earlier in this manual.

If changing this value does not correct a problem with the LCD backlight, then either the light sensor is bad or the backlight circuitry may not be functioning properly. If you suspect either of these cases, contact New Providence Marine Technical Support for additional testing procedures or for additional advice.

Problem:

An incorrect calibration value is entered inadvertently on a sensor channel that is otherwise working normally (i.e. an empty calibration value is set too high or a full value is set too low).

Test/Remedy:

If practical, drain the tank and set the empty calibration point then fill it and set the full.

If it is impractical to drain the tank and re-fill (i.e. a fuel tank), then the factory default calibration values for the troublesome sensor channel can be re-set.

By intentionally creating a calibration error, you can force the firmware in this display panel to store default calibration values for both empty and full in its memory. These values correspond to a sensor output of 0VDC (zero) for empty and 4VDC for full. These values are identical to the initial values programmed into the display panel when it was first tested at the factory. This return to default values clears possible bad calibration data which might make the sensor channel difficult to properly calibrate (i.e. an empty calibration value erroneously set with a full tank would otherwise prevent the setting of a proper full value until the empty point is set back to an appropriate empty value).

Creating this error intentionally can be done by simply setting the full calibration value then immediately setting the empty calibration value (see calibration procedure elsewhere in this manual). By doing this, you are trying to set identical empty and full values that the display panel firmware will not allow, and you should see the calibration error message screen. Once the error message is displayed, the factory default calibration values for that sensor channel are set.

The return to default calibration values will be reasonably accurate for most sensors, but for maximum accuracy, empty and full calibration for the tank should be done when it is practical to do so.

Limited Warranty

New Providence Marine Systems (New Providence) warrants to the original purchaser that this product is free of defects in materials or workmanship for a period of one year from the product's date of purchase. Should this product prove defective by reason of improper workmanship and/or materials within the warranty period, New Providence shall, at its sole option, repair or replace the product.

1. TO OBTAIN WARRANTY SERVICE, Consumer must deliver the product prepaid, together with a detailed description of the problem, to:

Ferriello Sales LLC

Attn: Warranty Service
478 S. Puerto Drive
Ivins, UT 84738 USA

When requesting warranty service, purchaser must present a sales slip or other document which establishes proof of purchase. THE RETURN OF THE PRODUCT REGISTRATION FORM IS NOT A CONDITION PRECEDENT OF WARRANTY COVERAGE. However, please complete and return the Product Registration Form so that New Providence can contact you should a question of safety arise.

2. THIS WARRANTY DOES NOT COVER defects caused by modifications, alterations, repairs or service of this product by anyone other than New Providence; defects in materials or workmanship supplied by others in the process of installation of this product; defects caused by installation of this product other than in accordance with the manufacturer's recommended installation instructions or standard industry procedures; physical abuse to, or misuse of, this product. This warranty also does not cover damages to equipment caused by fire, flood, external water, excessive corrosion, or Act of God.

3. ANY EXPRESS WARRANTY NOT PROVIDED HEREIN, AND ANY REMEDY FOR BREACH OF CONTRACT WHICH BUT FOR THIS PROVISION MIGHT ARISE BY IMPLICATION OR OPERATION OF LAW, IS HEREBY EXCLUDED AND DISCLAIMED. ALL IMPLIED WARRANTIES SUCH AS THOSE OF MERCHANTABILITY AND OF FITNESS FOR A PARTICULAR PURPOSE, IF APPLICABLE, AS WELL AS ANY IMPLIED WARRANTIES WHICH MIGHT ARISE BY IMPLICATION OF LAW, ARE EXPRESSLY LIMITED TO A TERM OF ONE YEAR. SOME STATES DO NOT ALLOW LIMITATIONS ON HOW LONG A LIMITED WARRANTY LASTS, SO THE ABOVE LIMITATION MAY NOT APPLY TO YOU.

4. UNDER NO CIRCUMSTANCES SHALL FERRIELLO SALES LLC BE LIABLE TO PURCHASER OR ANY OTHER PERSONS FOR ANY SPECIAL OR CONSEQUENTIAL DAMAGES, WHETHER ARISING OUT OF BREACH OF WARRANTY, BREACH OF CONTRACT, OR OTHERWISE. SOME STATES DO NOT ALLOW THE EXCLUSION OR LIMITATION OF INCIDENTAL OR CONSEQUENTIAL DAMAGES, SO THE ABOVE LIMITATION OR EXCLUSION MAY NOT APPLY TO YOU.

5. No other person or entity is authorized to make any express warranty, promise or affirmation of fact or to assume any other liability on behalf of New Providence in connection with its products except as specifically set forth in this warranty.

6. This warranty gives you specific legal rights, and you may also have other rights which vary from state to state.

7: LIMITED WARRANTY

Product Registration Form

In order for us to notify you about possible safety issues or to notify you about possible product upgrades we request the following information. Having this dated form on file in our offices also serves to establish your purchase date for warranty issues.

Owner Information:

Name: _____.
Address 1: _____.
Address 2: _____.
City: _____ State: _____ ZIP: _____.
Phone: (____) _____ - _____.
Email: _____.

Product Information:

Product(s) Purchased: _____.
Date Purchased (MM/DD/YY): ___/___/___.
Where Purchased From: _____.
Make/Model of Boat: _____.
of Tanks Monitored: _____.

Please fill out as clearly as possible and return to:

Ferriello Sales LLC
Attn: Product Registration
478 S. Puerto Drive
Ivins, UT 84738 USA

8:PRODUCT REGISTRATION